



# HARDSCAPE COLLECTION





## Why choose Stepstone ?

Stepstone creates beautiful, high-quality precast concrete products built to perform and last. We support our distribution partners with consistent quality, reliable production, and custom solutions for the homeowners and contractors they serve — Your Vision in Concrete.

# TABLE OF CONTENTS

Paver Collection.....	04
Pool Coping Collection.....	08
Wall Cap Collection .....	12
Garden Step Collection.....	18
Open Riser Step Tread Collection.....	19
Narrow Modular Pavers .....	22
Truncated Dome .....	23
Colors & Finishes.....	26



**Veranostone**

#2004 French Gray



**Veranostone**

#2013 Porcelain

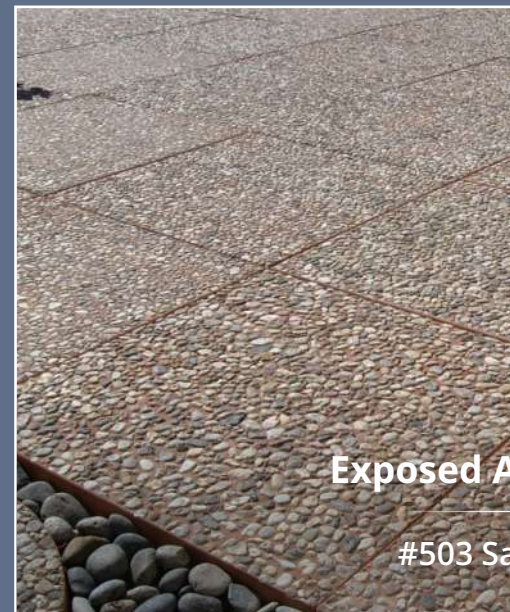

**Exposed Aggregate**

#503 Sandstone

## Paver Collection

01 | Exposed Aggregate

02 | Hermosastone

03 | Hexagon

04 | Sonorastone

05 | Veranostone





**Veranostone**

#2001 Granada White



**Aggregate**

anta Fe

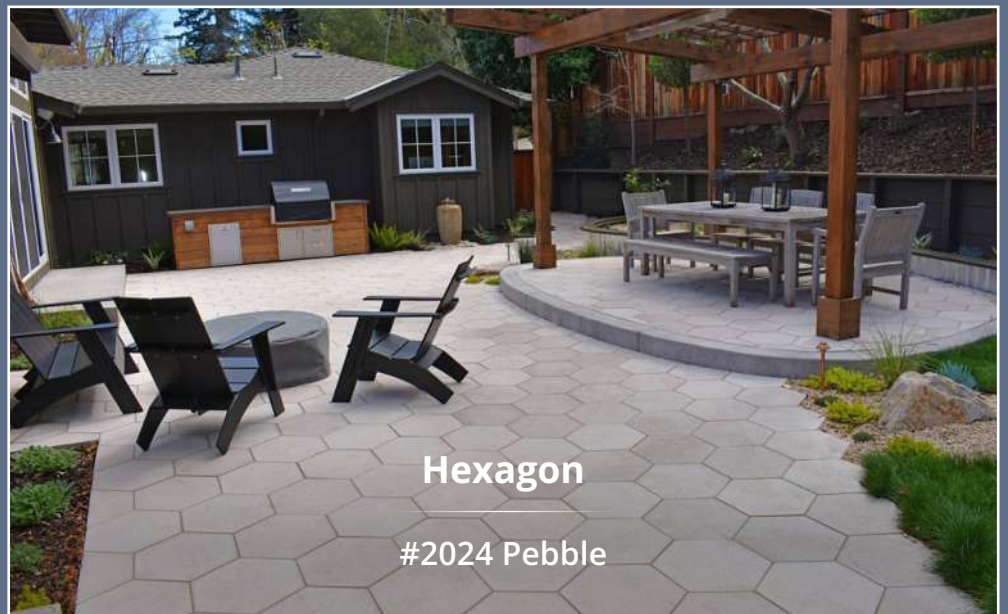

**Hexagon**

#2024 Pebble

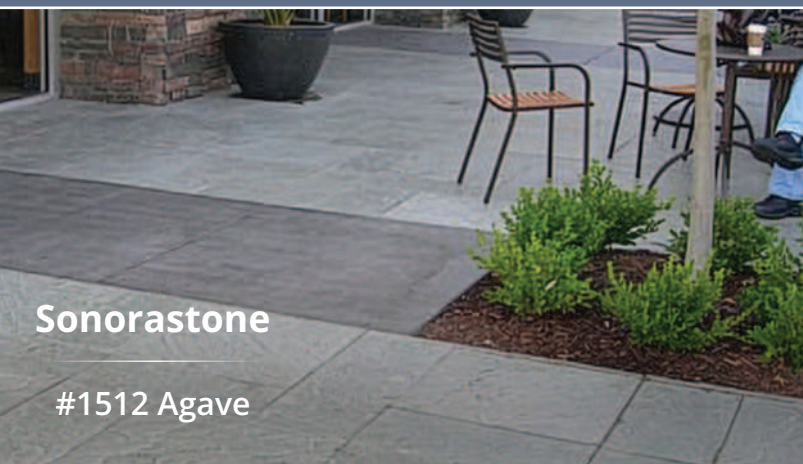

**Sonorastone**

#1512 Agave



**Veranostone**

#2001 Granada White

# Paver Specification

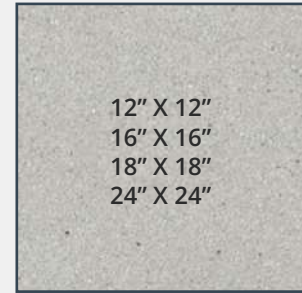
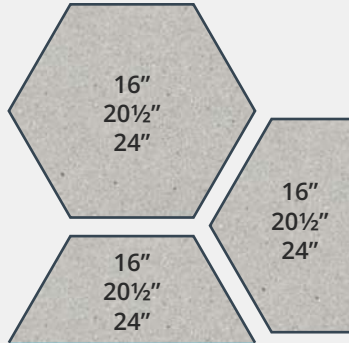
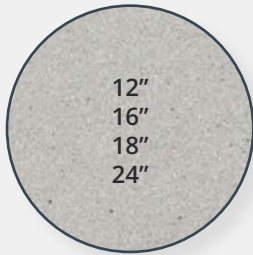

\*HEXAGONAL PAVERS UNAVAILABLE IN EXPOSED AGGREGATE FINISH  
 \*\*16" pavers are 2" thick; 20 1/2" and 24" are 2 1/2" thick.

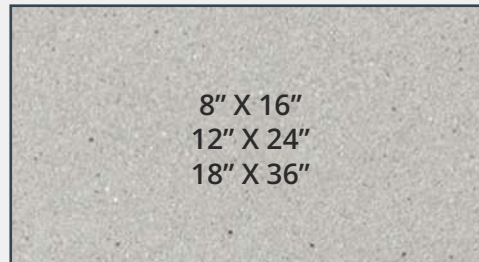
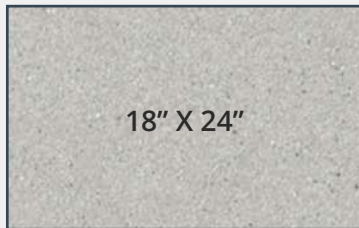

## Short Form Specification

<b>SIZES:</b>	ALL SIZES ARE 1 3/4" THICK; ALL SIZES ARE NOMINAL**
<b>MATERIAL:</b>	4,000 PSI HARDROCK CONCRETE, TYPE III CEMENT
<b>FINISH:</b>	VERANOSTONE® OR HERMOSASTONE® (REFER TO 26 )
<b>COLOR OPTIONS:</b>	REFER TO PAGE 26 - PHYSICAL SAMPLES ARE STRONGLY RECOMMENDED
<b>DETAILS:</b>	VISIT <a href="http://STEPSTONEDEALER.COM">STEPSTONEDEALER.COM</a> FOR DRAWINGS AND DIMENSIONS

# Paver Patterns

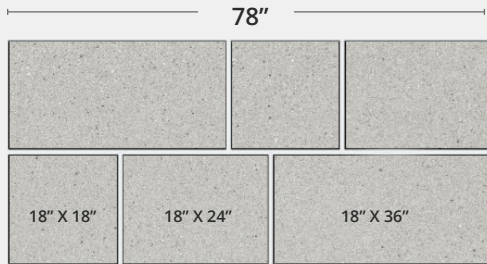

PATTERN 1 INCLUDES:	
2 PIECES	18" X 18"
2 PIECES	18" X 24"
2 PIECES	18" X 36"
<b>TOTAL: 19.5 SF</b>	

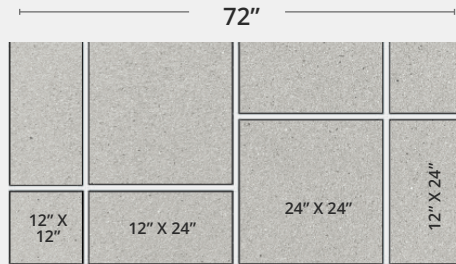

PATTERN 2 INCLUDES:	
2 PIECES	12" X 12"
4 PIECES	12" X 24"
2 PIECES	24" X 24"
<b>TOTAL: 18 SF</b>	

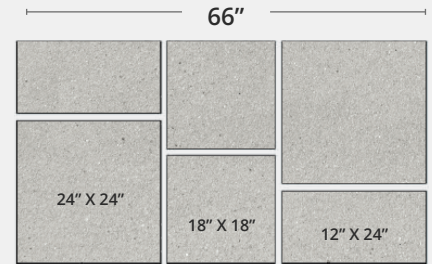

PATTERN 3 INCLUDES:	
2 PIECES	12" X 24"
2 PIECES	18" X 18"
2 PIECES	24" X 24"
<b>TOTAL: 16.5 SF</b>	

## ASHLAR PATTERN

PATTERN INCLUDES:		
7 PIECES	12" X 12" (1 SF EA)	7 SF
9 PIECES	12" X 24" (2 SF EA)	18 SF
8 PIECES	24" X 24" (4 SF EA)	32 SF
4 PIECES	18" X 18" (2.25 SF EA)	9 SF
3 PIECES	18" X 24" (3 SF EA)	9 SF
2 PIECES	18" X 36" (4.5 SF EA)	9 SF
<b>TOTAL SF PER PATTERN:</b>		<b>84 SF</b>

PATTERN 4 INCLUDES:	
2 PIECES	12" X 12"
4 PIECES	18" X 18"
2 PIECES	12" X 24"
<b>TOTAL: 15 SF</b>	

## ASHLAR PATTERN

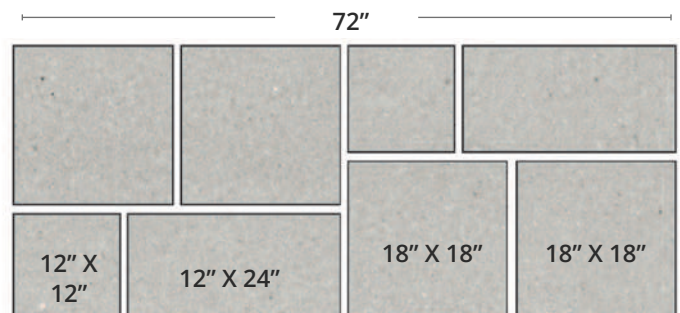
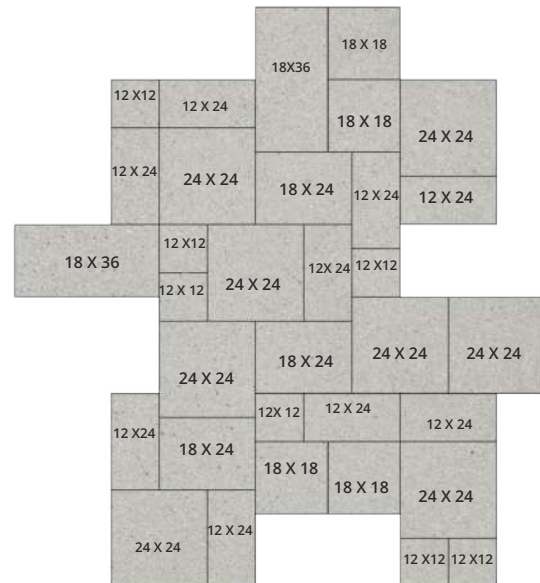



**Square Modular**

#2013 Porcelain

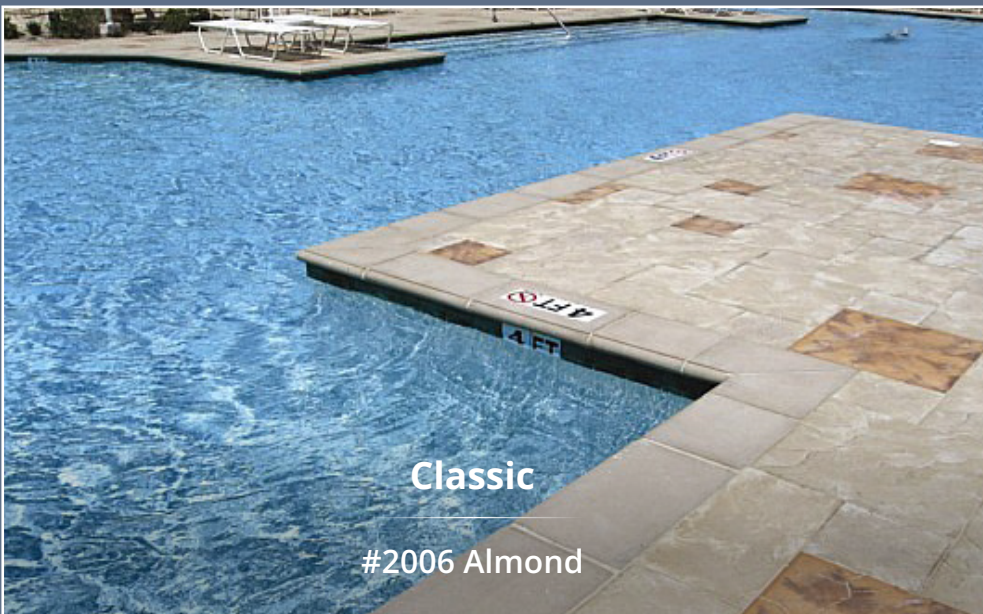

**Classic**

#2006 Almond



**Square M**

#2006 A

## Pool Coping Collection

- 01 | Classic
- 02 | Modern
- 03 | Square Modular



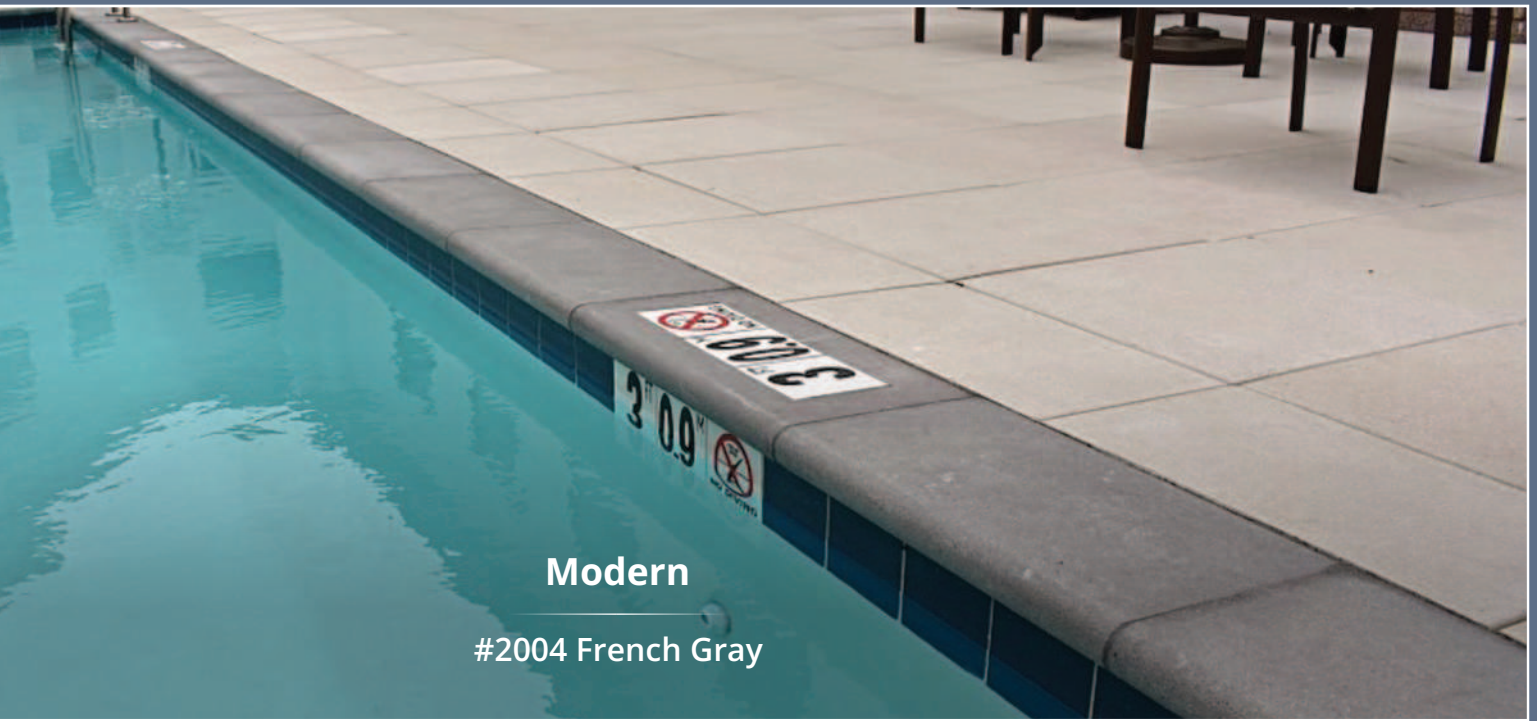

**Modern**

**#2004 French Gray**



**Modular**

**Almond**



**Square Modular**

**#2001 Granada White**



**Classic**

**#2001 Granada White**



**Modern**

**#2004 French Gray**

# Pool Coping Specification

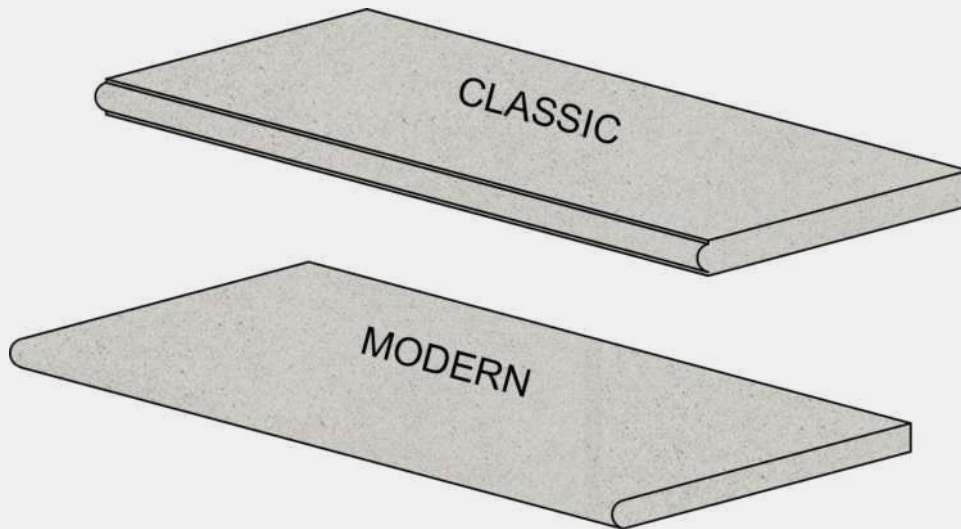

## SHORT FORM SPECIFICATION

### SIZES:

CLASSIC
14" X 24" X 2½"
INSIDE AND OUTSIDE CORNERS
INSIDE RADIUS: 1', 2', 3', 4', 6', 8'
OUTSIDE RADIUS: 2', 3', 4', 6', 8'
1" RADIUS BULLNOSE WITH 1/4" TOP AND BOTTOM REVEAL

MODERN
18" X 18" X 2"
18" X 24" X 2"
STRAIGHTS AND OUTSIDE CORNERS
1" RADIUS BULLNOSE

**ALL SIZES ARE NOMINAL**

<b>MATERIAL:</b>	4,000 PSI HARDROCK CONCRETE, TYPE III CEMENT
<b>FINISH:</b>	STIPPLED, VERANOSTONE® OR HERMOSASTONE® (REFER TO PAGE 26)
<b>COLOR OPTIONS:</b>	REFER TO PAGE 26 - PHYSICAL SAMPLES ARE STRONGLY RECOMMENDED
<b>DETAILS:</b>	VISIT <a href="http://STEPSTONEDEALER.COM">STEPSTONEDEALER.COM</a> FOR DRAWINGS, DIMENSIONS AND RADIUS FINDER
<b>BUILDING CODE:</b>	CHECK WITH LOCAL JURISDICTIONS FOR REQUIREMENTS

# Pool Coping Square Specification

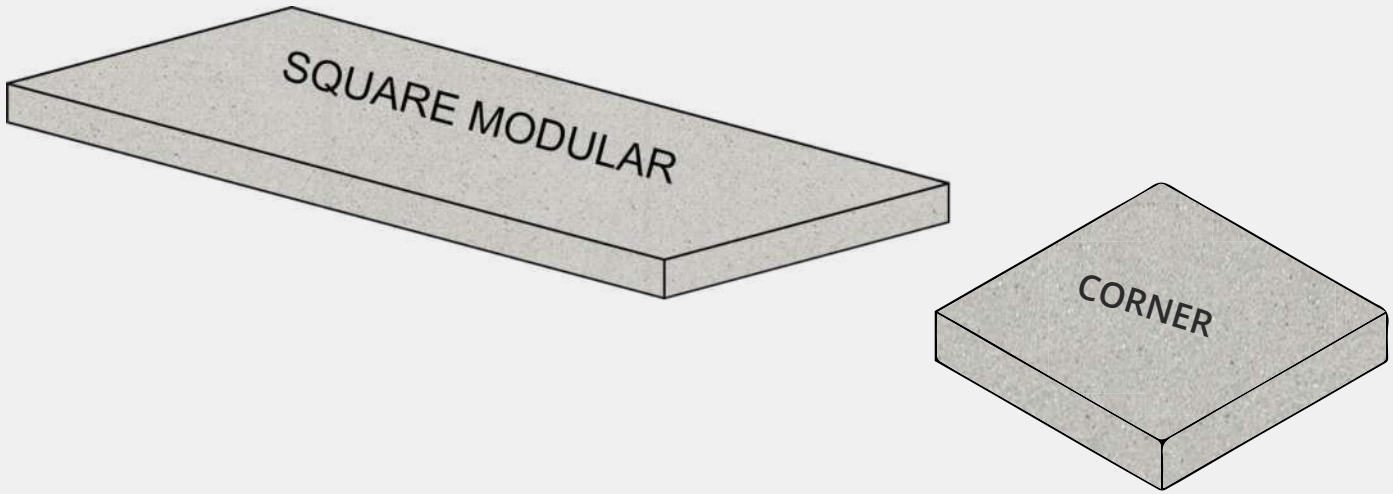

## SHORT FORM SPECIFICATION

### SIZES:

SQUARE MODULAR	
	12" X 24" X 2½"
	16" X 24" X 2½"
	16" X 36" X 2½"
	16" X 16" X 2½"
	16" OUTSIDE CORNERS
	OUTSIDE RADIUS: 2', 4', 6', 8'

### ALL SIZES ARE NOMINAL

MATERIAL:	4,000 PSI HARDROCK CONCRETE, TYPE III CEMENT
FINISH:	STIPPLED, VERANOSTONE® OR HERMOSASTONE® (REFER TO PAGE 26)
COLOR OPTIONS:	REFER TO PAGE 26 - PHYSICAL SAMPLES ARE STRONGLY RECOMMENDED
DETAILS:	VISIT <a href="http://STEPSTONEDEALER.COM">STEPSTONEDEALER.COM</a> FOR DRAWINGS, DIMENSIONS AND RADIUS FINDER
BUILDING CODE:	CHECK WITH LOCAL JURISDICTIONS FOR REQUIREMENTS

# Wall Cap Collection

- 01 | Classic Wall Cap (Peaked & Flat)
- 02 | Square Modular Wall Cap
- 03 | Square Wall Cap - 2 1/2"
- 04 | Sonorastone Wall Cap (Peaked & Flat)

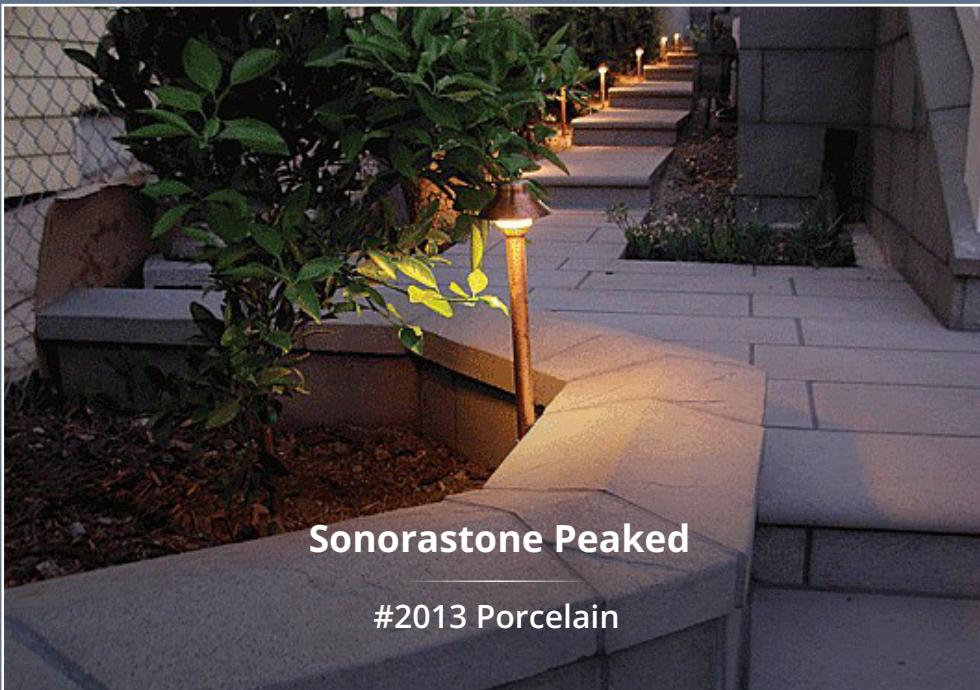



**Classic Wall Cap**

#501 Granada White



**ular Wall Cap**

Porcelain



**Square Modular Wall Cap**

#2013 Porcelain



**Classic Wall Cap**

#501 Granada White



**Sonorastone Flat**

#1504 French Gray

# Classic Wall Cap Specification

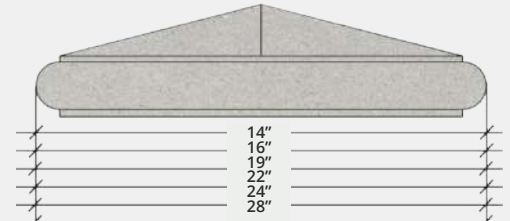
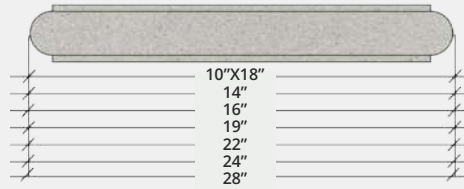
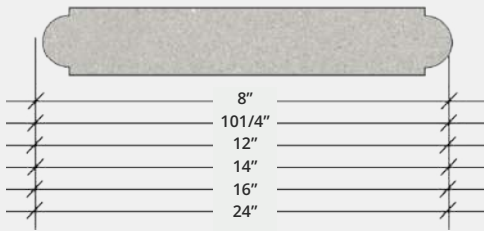

## SHORT FORM SPECIFICATION

### SIZES:

STRAIGHTS/ENDS	CORNERS	FLAT PILASTER CAP*	PEAKED PILASTER CAPS*
8" X 24" X 2½"	8" X 12" X 2½"	10" X 18" X 2½"	14" X 14" X 3¾"
10¼" X 24" X 2½"	10 1/4" X 12" X 2½"	14" X 14" X 2½"	16" X 16" X 4"
12" X 24" X 2½"	12" X 14" X 2½"	16" X 16" X 2½"	19" X 19" X 4¼"
14" X 24" X 2½"	14" X 16" X 2½"	19" X 19" X 2½"	22" X 22" X 4¾"
16" X 24" X 2½"	16" X 18" X 2½"	22" X 22" X 2½"	24" X 24" X 4½"
24" X 24" X 2½" (STRAIGHT ONLY)		24" X 24" X 2½"	28" X 28" X 5"
		28" X 28" X 2½"	*CUSTOM PILASTER CAP SIZES AVAILABLE

RADIUS PIECES	
WIDTH: 10¼"	RADIUS: 2', 3', 4', 6', 8', 10', 12', 14', 16'
WIDTH: 12", 14"	RADIUS: 4', 6', 8', 10', 12', 14', 16'
WIDTH: 16"	RADIUS: 4', 6', 8'

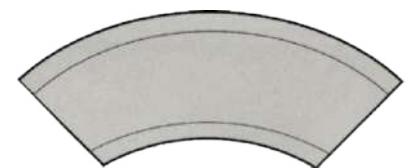

RADIUS IS MEASURED TO THE OUTSIDE EDGE ON ALL WALL CAP

### ALL SIZES ARE NOMINAL

WALL CAP MEASUREMENTS ARE TO THE OUTSIDE EDGE OF THE BULLNOSE WITH A 1" OVERHANG ON EACH SIDE.

MATERIAL:	4,000 PSI HARDROCK CONCRETE, TYPE III CEMENT
FINISH:	SMOOTH, VERANOSTONE® OR HERMOSASTONE® (REFER TO PAGE 26)
COLOR OPTIONS:	REFER TO PAGE 26 - PHYSICAL SAMPLES ARE STRONGLY RECOMMENDED
DETAILS:	VISIT <a href="http://STEPSTONEDEALER.COM">STEPSTONEDEALER.COM</a> FOR DRAWINGS AND DIMENSIONS

# Sonorastone Wall Cap Specification

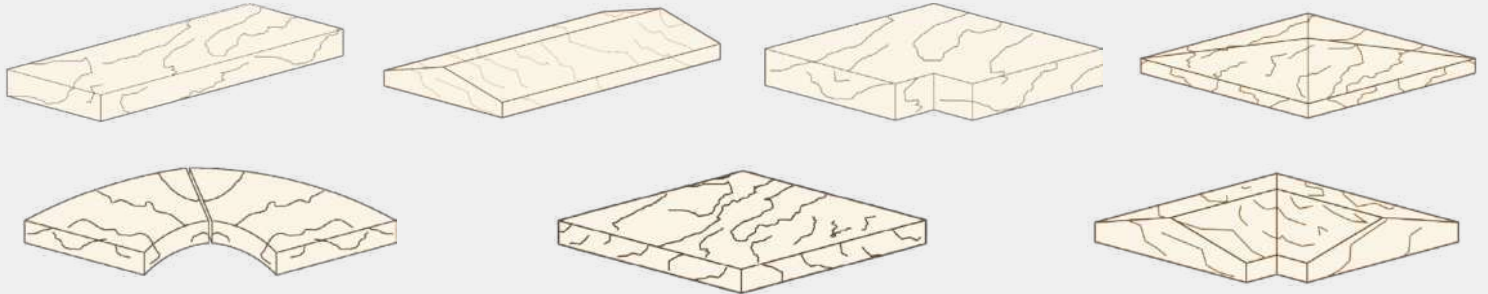

## SHORT FORM SPECIFICATION

### SIZES:

FLAT STRAIGHTS/ENDS	FLAT CORNERS	FLAT PILASTER CAP
7¼" x 24" x 2½"	7¼" x 10" x 2½"	18¼" x 18¼" x 3"
9¼" x 24" x 2½"	9¼" x 12" x 2½"	18¼" x 24¼" x 3"
13¼" x 24" x 2½"	13¼" x 16" x 2½"	24¼" x 24¼" x 3"
PEAKED CORNERS	PEAKED PILASTER CAP	PEAKED STRAIGHTS/ENDS
9¼" x 12" x 3"	13¼" x 13¼" x 3½"	9¼" x 24" x 3"
12¼" x 15" x 3¼"	18¼" x 18¼" x 4"	12¼" x 24" x 3¼"
16¼" x 19" x 3¾"	22¼" x 22¼" x 4¾"	16¼" x 24" x 3¾"
	24¼" x 24¼" x 43"	

### RADIUS PIECES -FLAT ONLY

WIDTH: 7-1/4", 9-1/4"	RADIUS: 4', 6', 8', 10'
WIDTH: 13-1/4"	RADIUS: 2' 2-3/4", 4', 6', 8', 10'

**ALL SIZES ARE NOMINAL**

<b>MATERIAL:</b>	4,000 PSI HARDROCK CONCRETE, TYPE III CEMENT
<b>FINISH:</b>	SONORASTONE® (SLATE-LIKE) (REFER TO PAGE 27)
<b>COLOR OPTIONS:</b>	REFER TO PAGE 27 - PHYSICAL SAMPLES ARE STRONGLY RECOMMENDED
<b>DETAILS:</b>	VISIT <a href="http://STEPSTONEDEALER.COM">STEPSTONEDEALER.COM</a> FOR MORE INFORMATION

# Square Modular Wall Cap Specification

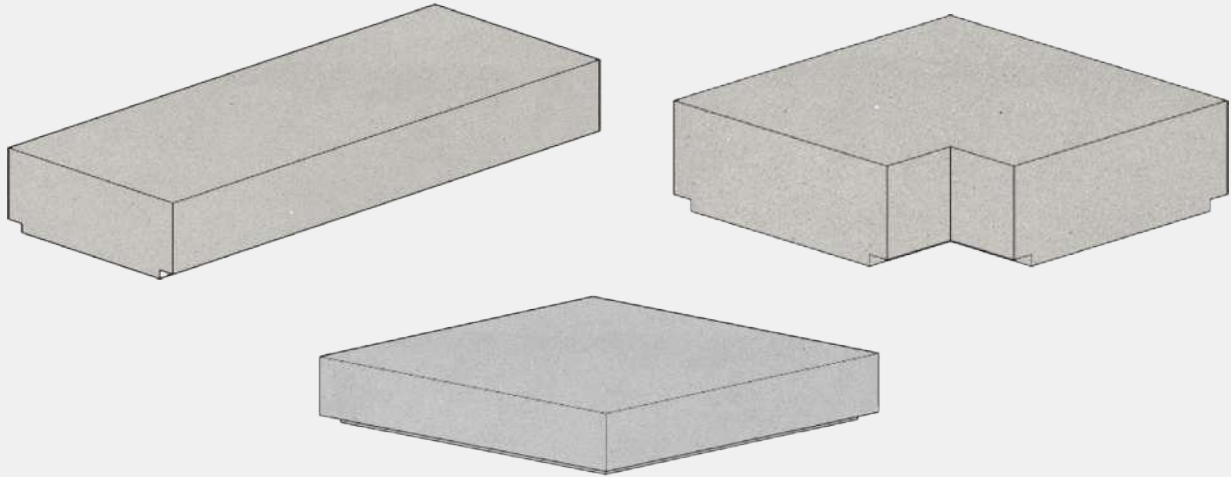

## SHORT FORM SPECIFICATION

### SIZES:

STRAIGHTS/ENDS
7¼" X 24" X 3¾"
9¼" X 24" X 3¾"
13¼" X 24" X 3¾"
20¼" X 24" X 3¾"

CORNERS
7¼" X 10" X 3¾"
9¼" X 12" X 3¾"
13¼" X 16" X 3¾"
20¼" X 23" X 3¾"

PILASTER CAPS
13½" X 13½" X 3¾"
15½" X 15½" X 3¾"
20" X 20" X 3¾"
23½" X 23½" X 3¾"
27½" X 27½" X 3¾"

### RADIUS PIECES

WIDTH: 9 ¼"

RADIUS: 2', 4', 6', 8'

### ALL SIZES ARE NOMINAL

MATERIAL:	4,000 PSI HARDROCK CONCRETE, TYPE III CEMENT
FINISH:	SMOOTH, VERANOSTONE® OR HERMOSASTONE® (REFER TO PAGE 26)
COLOR OPTIONS:	REFER TO PAGE 26 - PHYSICAL SAMPLES ARE STRONGLY RECOMMENDED
DETAILS:	VISIT <a href="http://STEPSTONEDEALER.COM">STEPSTONEDEALER.COM</a> FOR DRAWINGS AND DIMENSIONS

# Square Wall Cap Specification

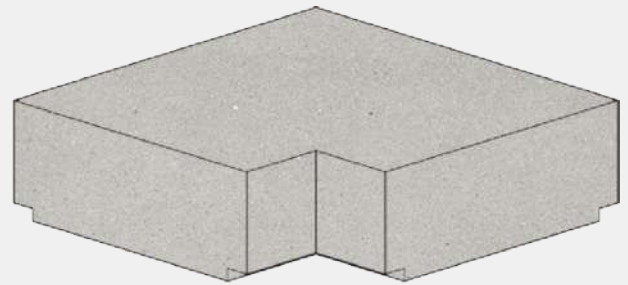
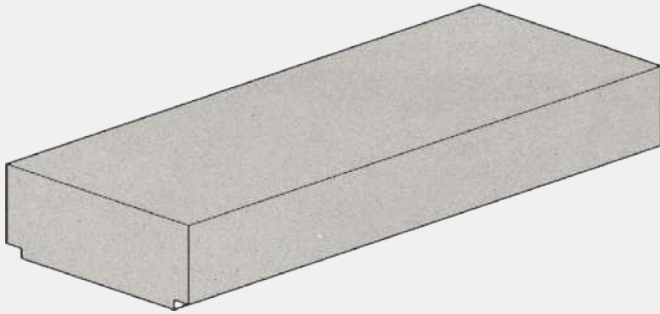

## SHORT FORM SPECIFICATION

### SIZES:

#### STRAIGHTS/ENDS

9 1/4" X 24" X 2 1/4"

#### CORNERS

9 1/4" X 12" X 2 1/2"

#### RADIUS PIECES

WIDTH: 9 1/4"

RADIUS: 2', 4', 6', 8'

### ALL SIZES ARE NOMINAL

<b>MATERIAL:</b>	4,000 PSI HARDROCK CONCRETE, TYPE III CEMENT
<b>FINISH:</b>	SMOOTH, VERANOSTONE® OR HERMOSASTONE® (REFER TO PAGE 26)
<b>COLOR OPTIONS:</b>	REFER TO PAGE 26 - PHYSICAL SAMPLES ARE STRONGLY RECOMMENDED
<b>DETAILS:</b>	VISIT <a href="http://STEPSTONEDEALER.COM">STEPSTONEDEALER.COM</a> FOR DRAWINGS AND DIMENSIONS



**Classic**  
#2006 Almond



**Square Modular**  
#2013 Porcelain



**Classic**  
#2006 Almond



**Square Modular**  
#2007 Cafe Brown



**Modern**  
#2006 Almond



**Modern**  
#2013 Porcelain

## Garden Step Collection

- 01 | Classic
- 02 | Modern
- 03 | Square Modular

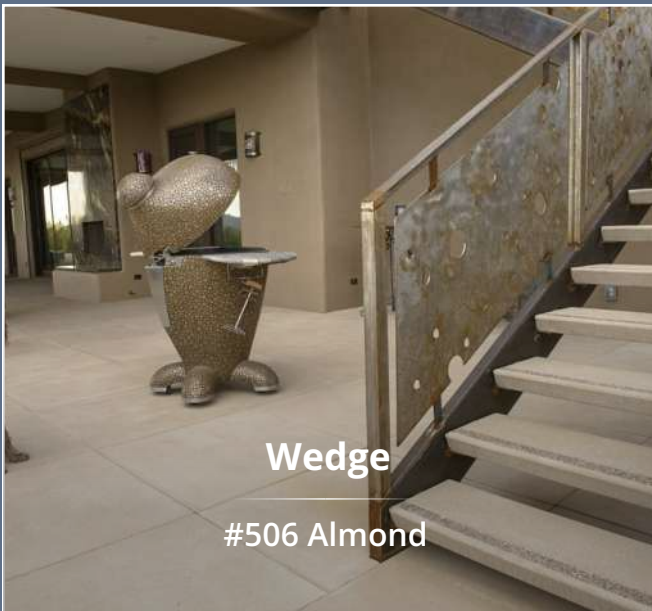

**Wedge**

#506 Almond

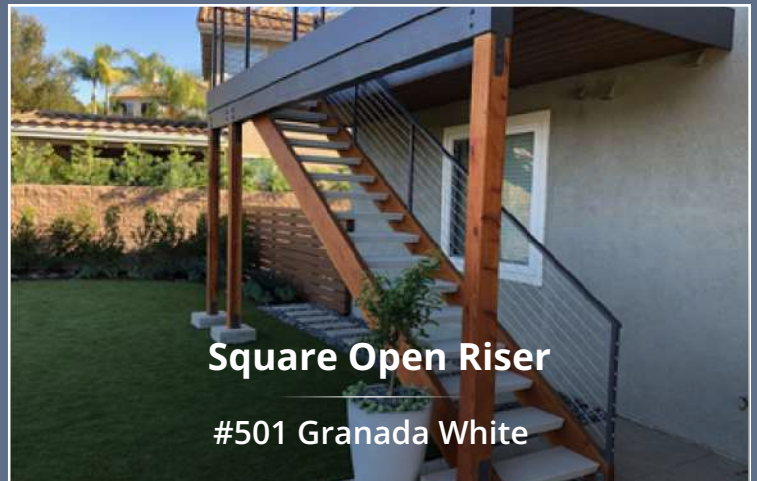

**Square Open Riser**

#501 Granada White



**Wedge**

#504 French Gray



**Open Riser**

#2013 Porcelain



**Bullnose**

#E 503 Santa Fe Buff

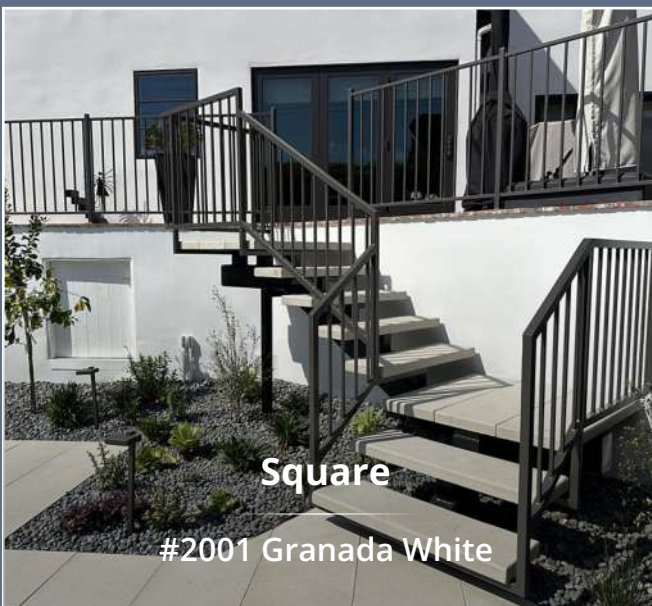

**Square**

#2001 Granada White

## Open Riser Step Tread Collection

- |    |  |          |    |  |        |
|----|--|----------|----|--|--------|
| 01 |  | Bevel    | 03 |  | Square |
| 02 |  | Bullnose | 04 |  | Wedge  |

# Garden Step Specification

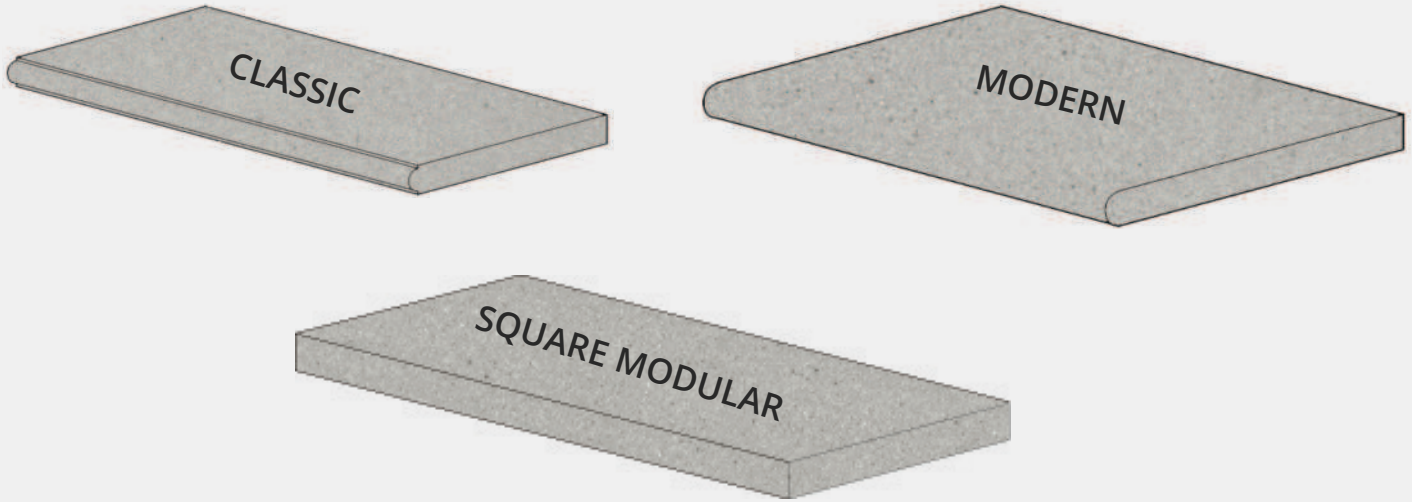

## SHORT FORM SPECIFICATION

### SIZES:

CLASSIC
14" X 24" X 2½"
INSIDE & OUTSIDE CORNERS
14" X 16" X 2½"
INSIDE RADIUS: 1', 2', 3', 4', 6', 8'
OUTSIDE RADIUS: 2', 3', 4', 6', 8'
1" RADIUS BULLNOSE WITH 1/4" TOP AND BOTTOM REVEAL

MODERN
18" X 18" X 2"
18" X 24" X 2"
STRAIGHTS & OUTSIDE CORNERS
1" RADIUS BULLNOSE

RISER BLOCK
3" X 4" X 24"

RISER TILE
6" X 12" X 1"

SQUARE MODULAR
12" X 24" X 2½"
16" X 24" X 2½"
16" X 36" X 2½"
16" X 16" X 2½"
16" OUTSIDE CORNERS
OUTSIDE RADIUS: 2', 4', 6', 8'

### ALL SIZES ARE NOMINAL

MATERIAL:	4,000 PSI HARDROCK CONCRETE, TYPE III CEMENT
FINISH:	STIPPLED, VERANOSTONE® OR HERMOSASTONE® (REFER TO PAGE 26)
COLOR OPTIONS:	REFER TO PAGE 26 - PHYSICAL SAMPLES ARE STRONGLY RECOMMENDED
DETAILS:	<a href="http://STEPSTONEDEALER.COM">STEPSTONEDEALER.COM</a> FOR DRAWINGS, DIMENSIONS AND RADIUS FINDER
BUILDING CODE:	CHECK WITH LOCAL JURISDICTIONS FOR REQUIREMENTS

# Open Riser Step Tread Specification

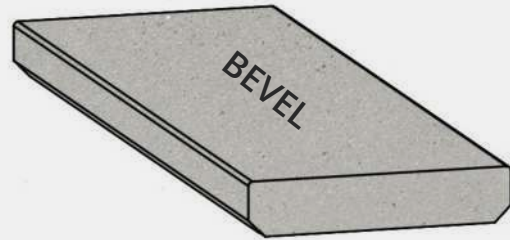
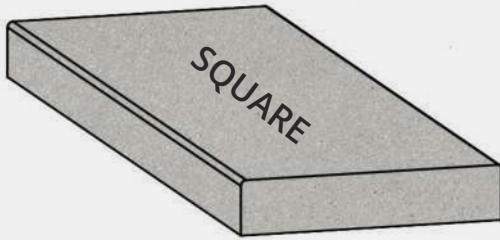
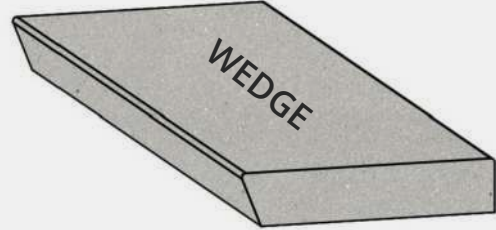

## SHORT FORM SPECIFICATION

<b>SIZES:</b>	11" X 36" UP TO 48" X 2 ½" ALL SIZES ARE NOMINAL
<b>MATERIAL:</b>	5,000 PSI HARDROCK CONCRETE, TYPE III CEMENT
<b>REINFORCEMENT:</b>	ZINC-PLATED WELDED WIRE MESH
<b>FINISH:</b>	BROOM, EXPOSED AGGREGATE, VERANOSTONE® OR HERMOSASTONE® (REFER TO PAGE 27)
<b>COLOR OPTIONS:</b>	REFER TO PAGE 27 - PHYSICAL SAMPLES ARE STRONGLY RECOMMENDED
<b>NOSE FINISH:</b>	SMOOTH OR EXPOSED AGGREGATE
<b>DETAILS:</b>	VISIT <a href="http://STEPSTONEDEALER.COM">STEPSTONEDEALER.COM</a> FOR DRAWINGS AND DIMENSIONS
<b>BUILDING CODE:</b>	CHECK WITH LOCAL JURISDICTIONS FOR REQUIREMENTS



#2006 Almond &  
2010 Caramel



#2013 Porcelain &  
#2011 Charcoal



#2014  
French Gray



#2001 Granada White  
& #2004 French Gray



#2006 Almond



#2006 Almond &  
2010 Caramel

## Narrow Modular Pavers



#501 Granada White



# FS Custom Federal Yellow



#516 Brick Red



#514 Yellow



#511 Charcoal



## Truncated Dome

# Narrow Modular Paver Specification

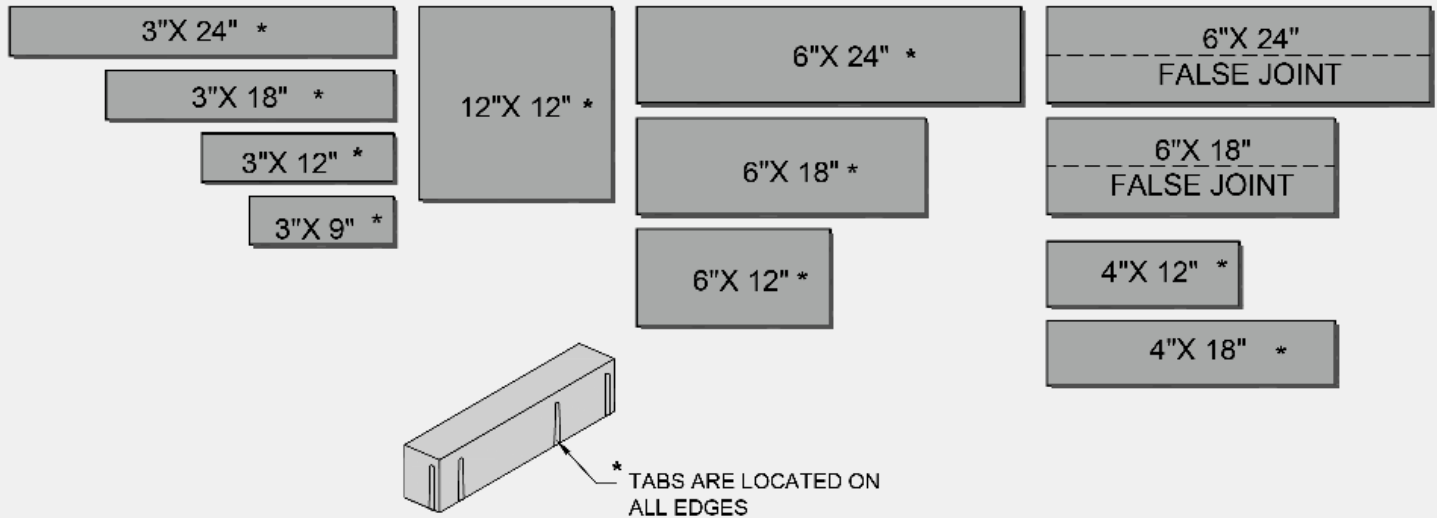

## SHORT FORM SPECIFICATION

<b>SIZES:</b>	ALL SIZES ARE 4" THICK; ALL SIZES ARE NOMINAL
<b>MATERIAL:</b>	4,000 PSI HARDROCK CONCRETE, TYPE III CEMENT
<b>FINISH:</b>	VERANOSTONE® OR HERMOSASTONE® (REFER TO PAGE 26)
<b>COLOR OPTIONS:</b>	REFER TO PAGE 26 - PHYSICAL SAMPLES ARE STRONGLY RECOMMENDED
<b>DETAILS:</b>	VISIT <a href="http://STEPSTONEDEALER.COM">STEPSTONEDEALER.COM</a> FOR DRAWINGS AND DIMENSIONS

# Truncated Dome Specification

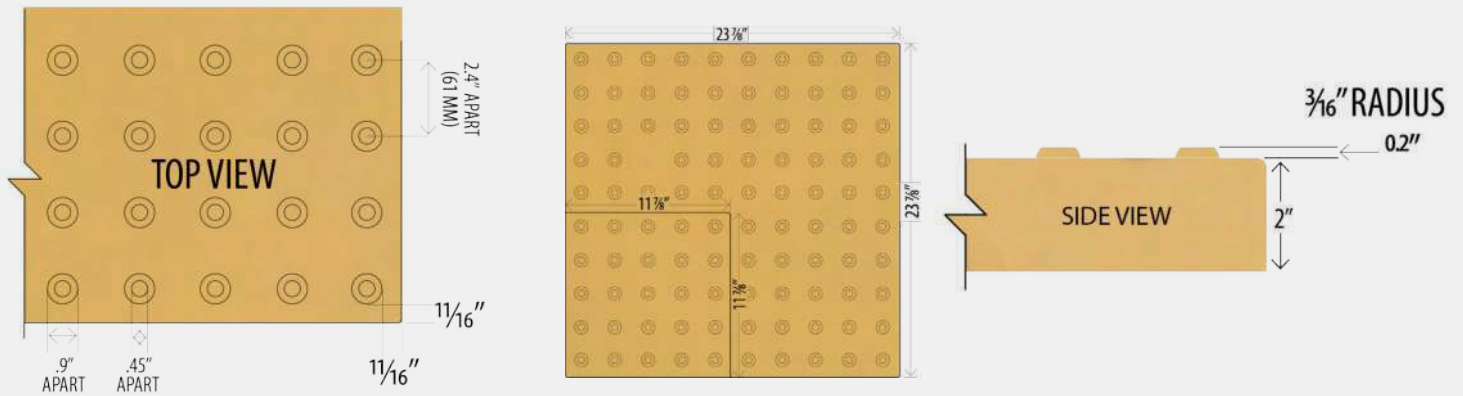

## SHORT FORM SPECIFICATION

<b>SIZES:</b>	12" X 12" AND 24" X 24" ARE 2" THICK; ALL SIZES ARE NOMINAL ORIENTATION OF DOMES ON CAST PAVERS IS +/- 1/16" OF SPECIFIED DIMENSIONS ALL DIMENSIONS LISTED ARE INTENDED TO MEET ADA SPECIFICATIONS
<b>MATERIAL:</b>	4,000 PSI HARDROCK CONCRETE, TYPE III CEMENT
<b>FINISH:</b>	STIPPLED OR SANDBLAST (REFER TO PAGE 27)
<b>COLOR OPTIONS:</b>	REFER TO PAGE 27 - PHYSICAL SAMPLES ARE STRONGLY RECOMMENDED
<b>DETAILS:</b>	VISIT <a href="http://STEPSTONEDEALER.COM">STEPSTONEDEALER.COM</a> FOR DRAWINGS AND DIMENSIONS

# VERANOSTONE® COLORS

---

GRANADA WHITE 2001	FRENCH GRAY 2004	ICEBERG GREEN 2005	ALMOND 2006	CAFE BROWN 2007	CARAMEL 2010
AGAVE 2012	PORCELAIN 2013	BRICK RED 2016	KONA 2021	PEBBLE 2024	ADOBE 2025

# HERMOSASTONE® COLORS

---

GRANADA WHITE 1901	FRENCH GRAY 1904	ICEBERG GREEN 1905	ALMOND 1906	CAFE BROWN 1907	CARAMEL 1910
AGAVE 1912	PORCELAIN 1913	BRICK RED 1916	KONA 1921	PEBBLE 1924	ADOBE 1925

# CLASSIC® COLORS (SMOOTH & STIPPLED FINISH)

---

GRANADA WHITE 501	FRENCH GRAY 504	ICEBERG GREEN 505	ALMOND 506	CAFE BROWN 507	CARAMEL 510
AGAVE 512	PORCELAIN 513	BRICK RED 516	KONA 521	PEBBLE 524	ADOBE 525

# SONORASTONE® COLORS

GRANADA WHITE

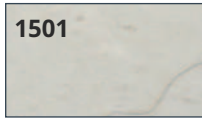

FRENCH GRAY

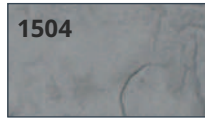

ALMOND

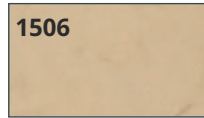

CAFE BROWN

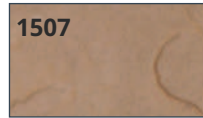

CARAMEL

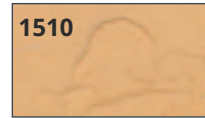

AGAVE

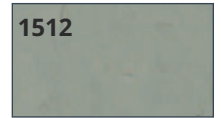

PORCELAIN

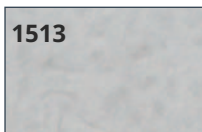

BRICK RED

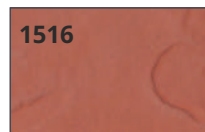

KONA

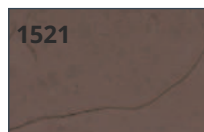

PEBBLE

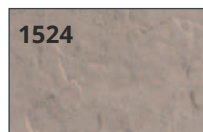

ADOBE

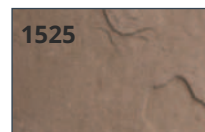

# STEPTREAD COLORS\*

CAFE BROWN

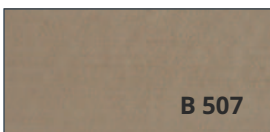

SANTA FE BUFF

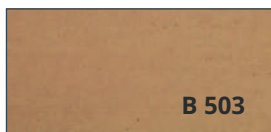

FRENCH GRAY

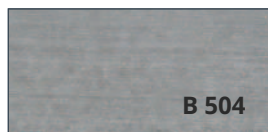

GRANADA WHITE

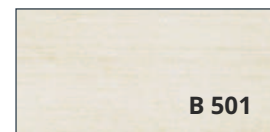

CARAMEL

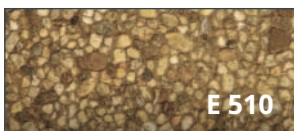

SANTA FE BUFF

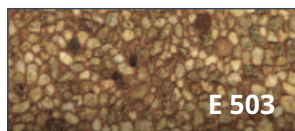

GRANADA WHITE

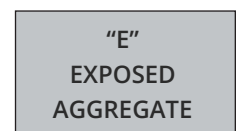
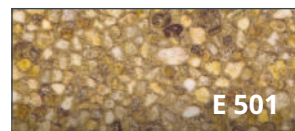

\*STEPTREADS ARE ALSO AVAILABLE IN VERANOSTONE® AND HERMOSASTONE®

# TRUNCATED DOME COLORS

CHARCOAL #511



YELLOW #514

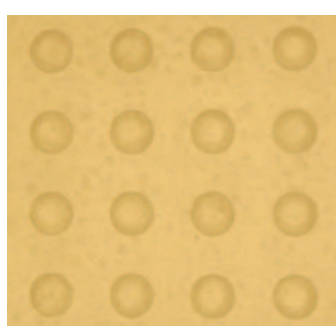

BRICK RED #516

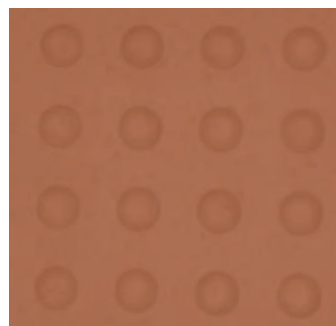

CUSTOM FEDERAL YELLOW  
FS 33538, #517

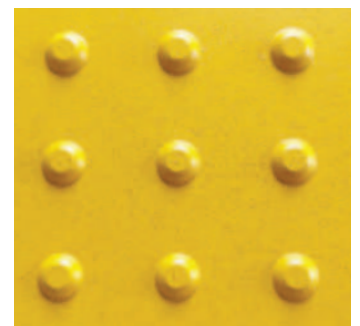

DUE TO LIGHTING AND PHOTO EDITING, IMAGES DO NOT ALWAYS ACCURATELY DEPICT OUR PRODUCT COLORS. ALL OF OUR PRODUCTS ARE MADE BY HAND FROM NATURAL MATERIALS. VARIATIONS IN COLOR ARE TO BE EXPECTED. WE ALWAYS RECOMMEND SELECTING COLORS FROM ACTUAL CONCRETE SAMPLES. PLEASE FEEL FREE TO CONTACT US FOR SAMPLES AT [800.572.9029](tel:800.572.9029) OR USE OUR WEBSITE [STEPSTONEDEALER.COM](http://STEPSTONEDEALER.COM).



WORKSHEETS



FAQs & REPORTS



STEPSTONE PICS



800.572.9029 | 310.217.2378



STEPSTONEDEALER.COM

VISIT [STEPSTONEDEALER.COM](http://STEPSTONEDEALER.COM) FOR OUR FULL PRODUCT CATALOGUE

PLEASE NOTE: ALL OF OUR PRODUCTS ARE MADE BY HAND FROM NATURAL MATERIALS. VARIATIONS IN COLOR ARE TO BE EXPECTED. TO CONFIRM COLOR, PLEASE REFER TO ACTUAL CONCRETE SAMPLES BEFORE PLACING ORDER. SOME MINOR CHIPPING MAY RESULT FROM SHIPPING, BUT IS NOT DETRIMENTAL TO APPEARANCE OR FUNCTION. STEPSTONE, LLC RECOMMENDS SEALING TO AID IN GROUT REMOVAL AND CLEANING PRIOR TO INSTALLATION. GROUT NATURALLY WILL BOND WITH CONCRETE. IMMEDIATELY REMOVE ANY GROUT SLURRY THAT COMES IN CONTACT WITH THE FINISHED FACE OF THE PRECAST CONCRETE PIECES. ALL SIZES ARE NOMINAL. SEE DETAILS FOR FURTHER INFORMATION. AVAILABLE IN OTHER STANDARD COLORS.